

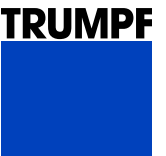

TRUMPF@Lean Café
**Covid, Logistics, Ukraine, Supply chain crisis...
our approach and learnings over the last 2 years**

Philipp Schüll | Head of Order Fulfillment | Member of Management Board BU LT | Interim COO TRUMPF UK



TRUMPF is...



Family business



Technology leader

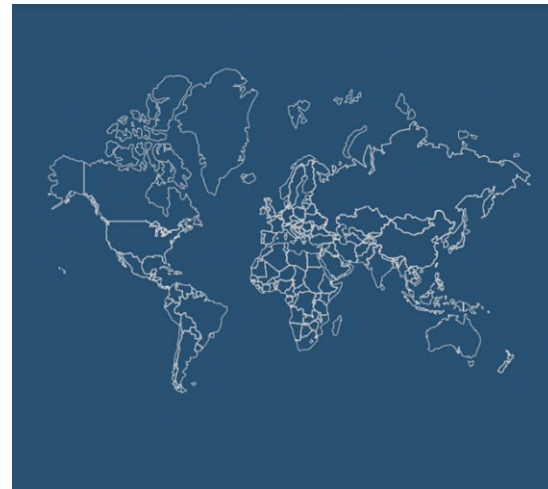

Close to the customer

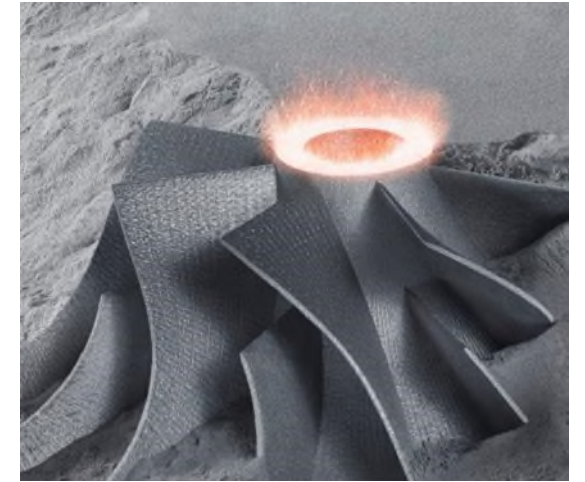

Innovation guarantor

Our business divisions

Share of sales revenues in 2020/21

Machine tools for flexible sheet metal processing



Sales revenues 2020/21

2,039 bn. €

-3.9 %

Laser technology

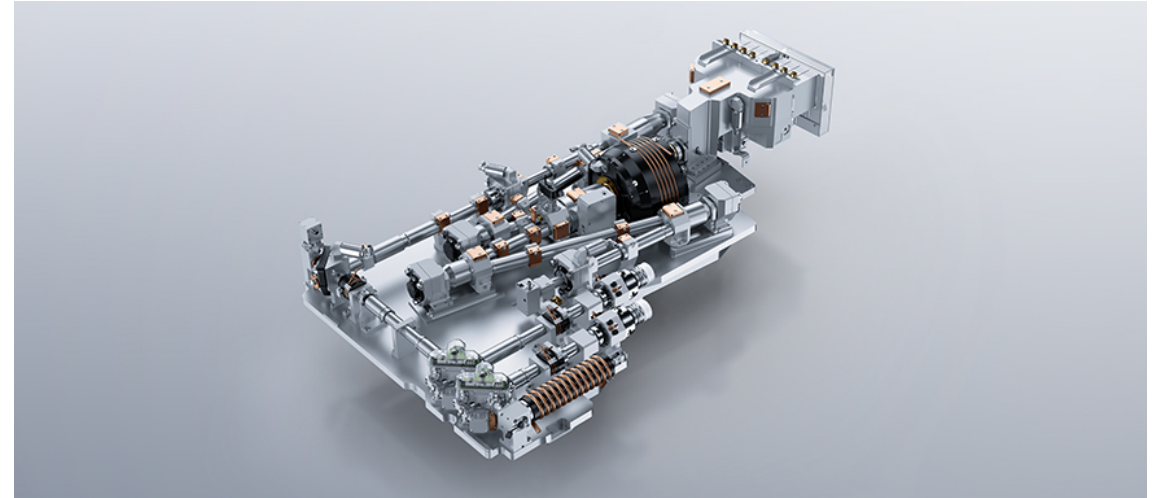

Sales revenues 2020/21

1,322 bn. €

+10.4 %

The most effective possible fulfilment of customer requirements with the most efficient possible use of resources

Basic Understanding of SYNCHRO

TRUMPF AND ITS SUPPLIERS

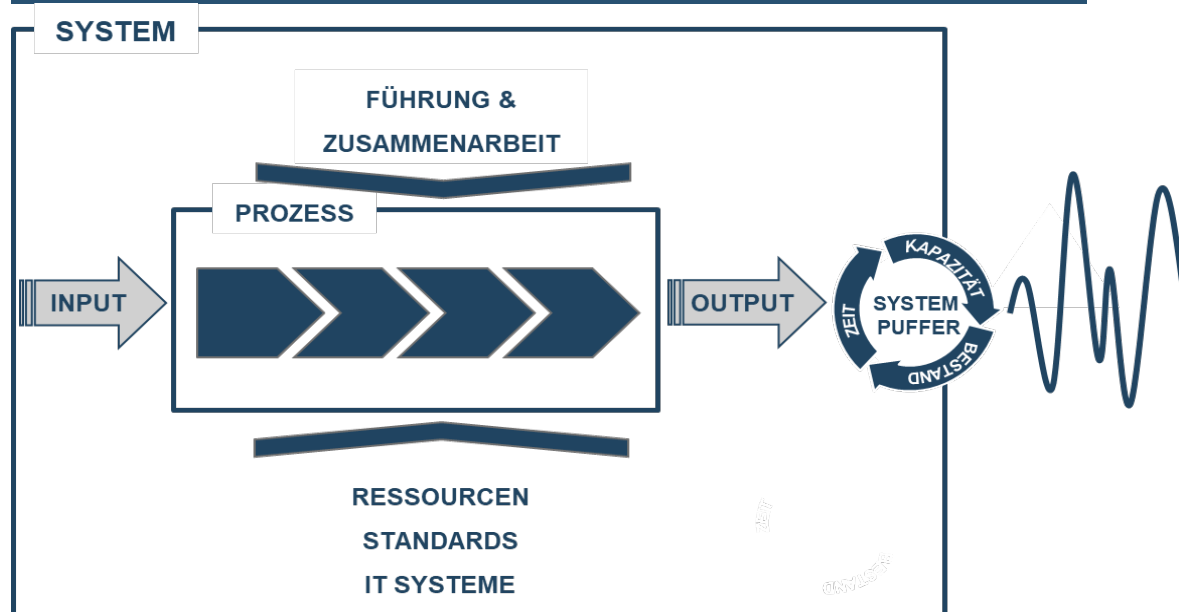

CUSTOMER



EFFICIENCY = PERFECT USE OF RESOURCES



+

EFFECTIVENESS = MEET THE CUSTOMER EXPECTATIONS

CUSTOMER SATISFACTION

SYNCHRO strives for excellence in processes, management as well as behaviour

SYNCHRO House

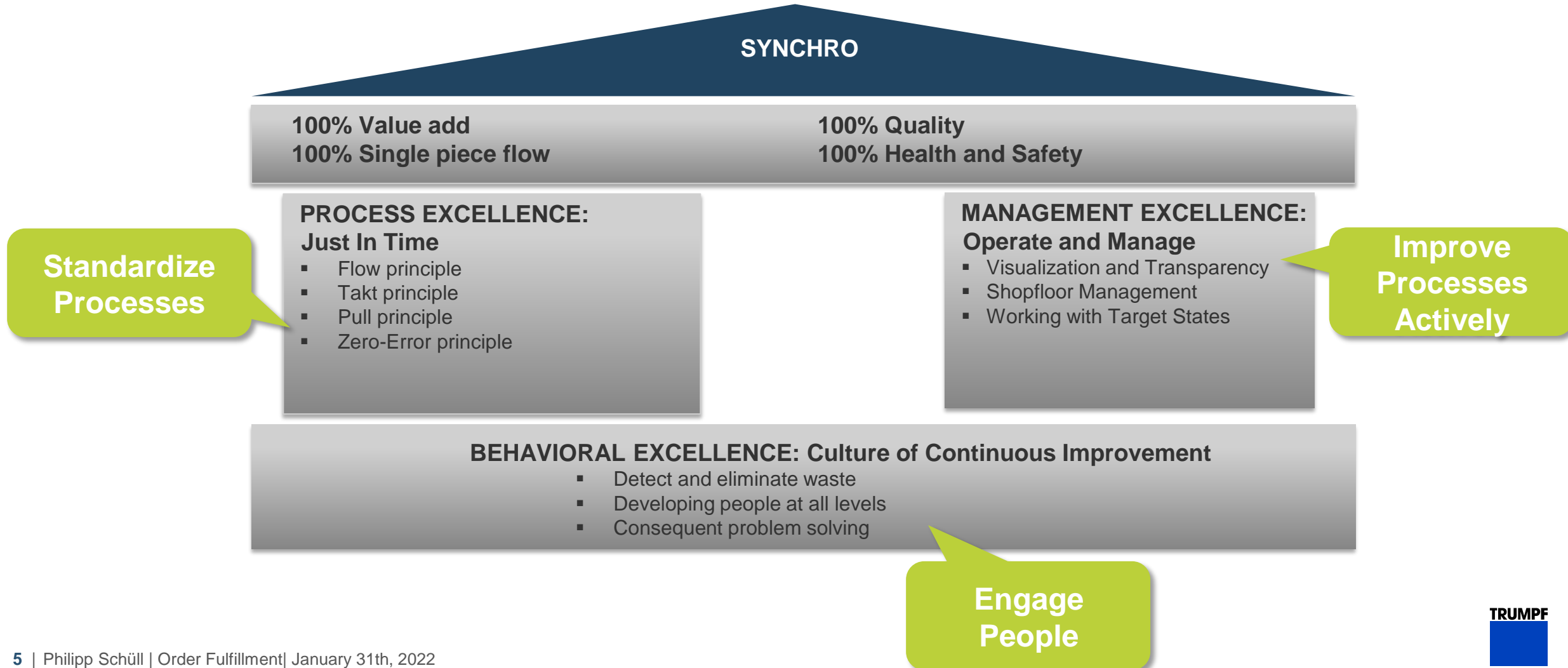

Process Excellence needs management and behavioural excellence for sustainable improvement

SYNCHRO as a “tool box”

1998
Synchrone
Produktion

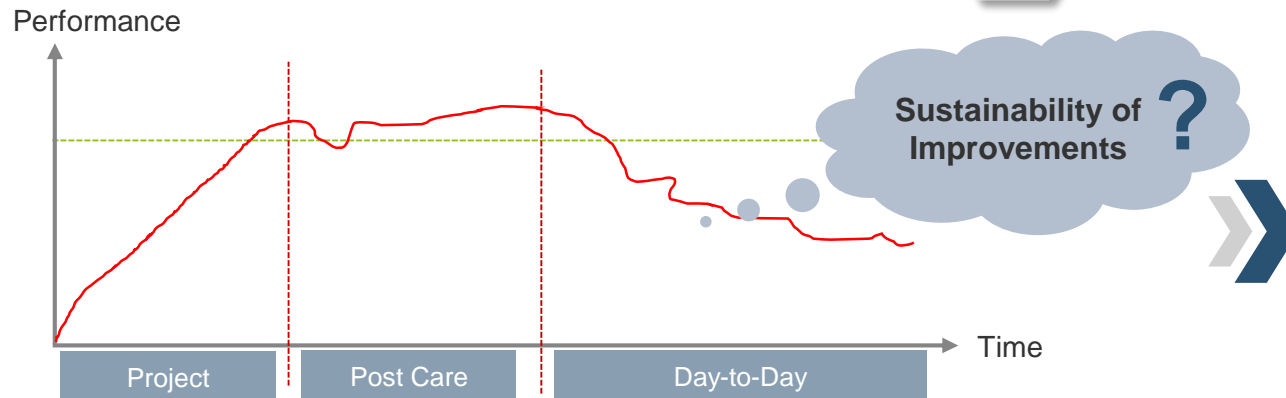

SYNCHRO as way of thinking, attitude and behaviour

2010
SYNCHRO
plus

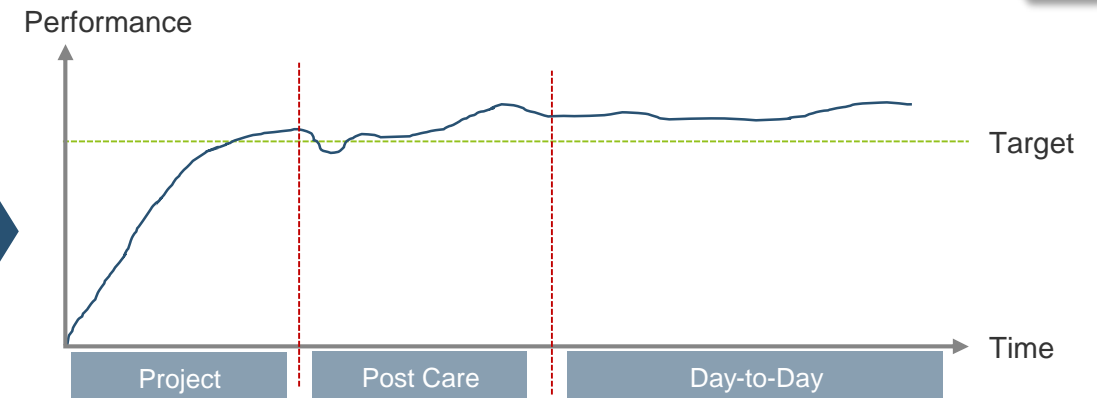

Projects and workshop based improvements with temporary effects

- *System lives on a few motivated managers*
- *Project-based, top down*
- *Focus on tools and methods*

Continuous responsibility for process stability and improvement

- *How do all executives behave on the shop floor?*
- *How do we make continuous improvement?*
- *Focus on people and culture: How do we develop employee skills? What does our culture look like?*

Leaders play a decisive role in SYNCHRO

Behaviours and attitudes of leaders

Trust

1. Tolerate failures as long as people learn by them
2. Give kudos
3. Support and collaborate
4. Delegate decision

Welcome Problems

1. Create a burning platform
2. Go all the way for the root causes – not short
3. Have a positive attitude
4. Visualize the facts

Challenge

1. Raise the bar
2. Set clear expectations
3. Ask for waste and question processes permanently
4. Spend time on site and learn

Develop and Promote People

1. Share knowledge
2. Train people
3. Give feedback
4. Ask questions and support

Current macro economic situation

The succession of five crises amplifies their effects

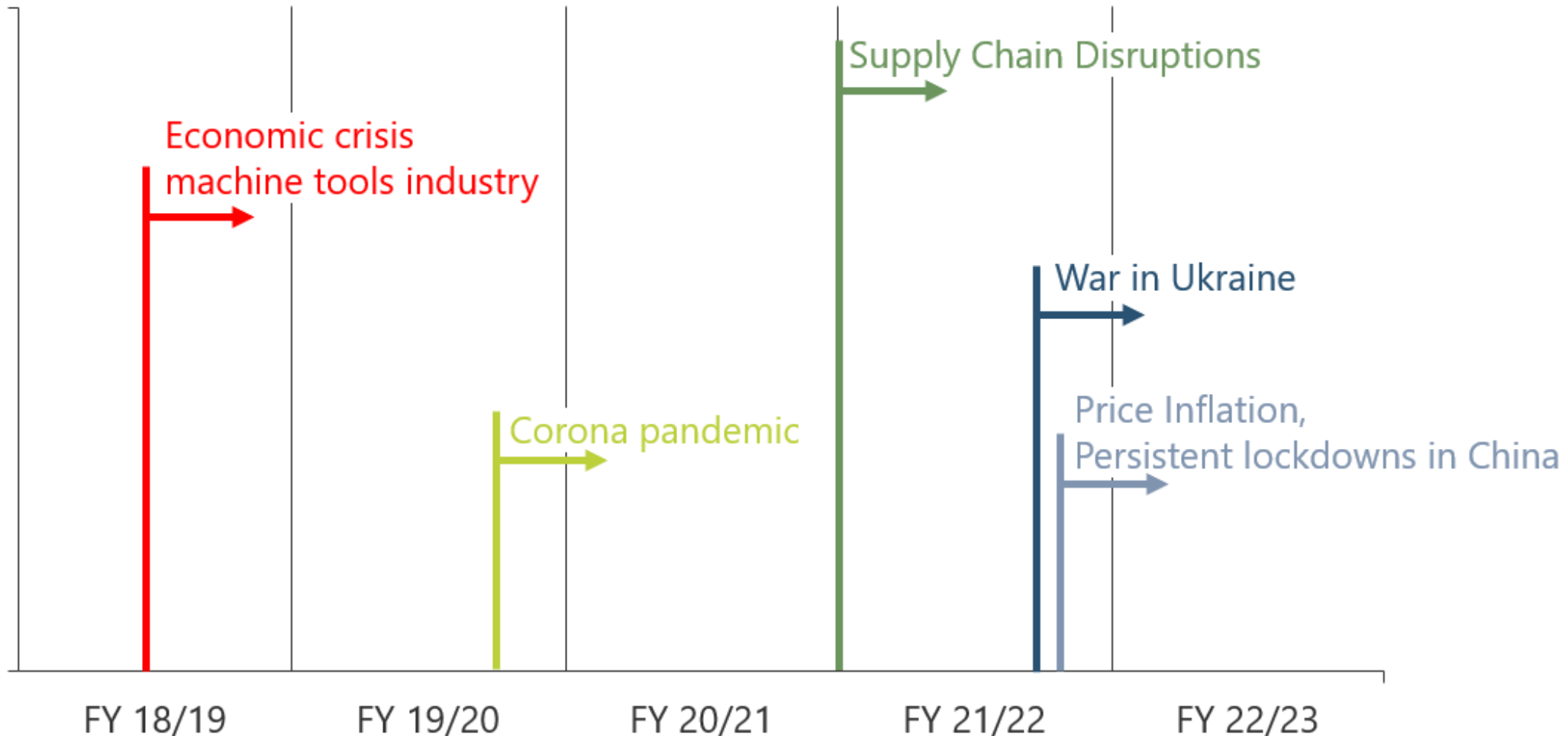

Situation on logistics and energy

Delivery times and freight rates increase since start of pandemic

Freight rate index

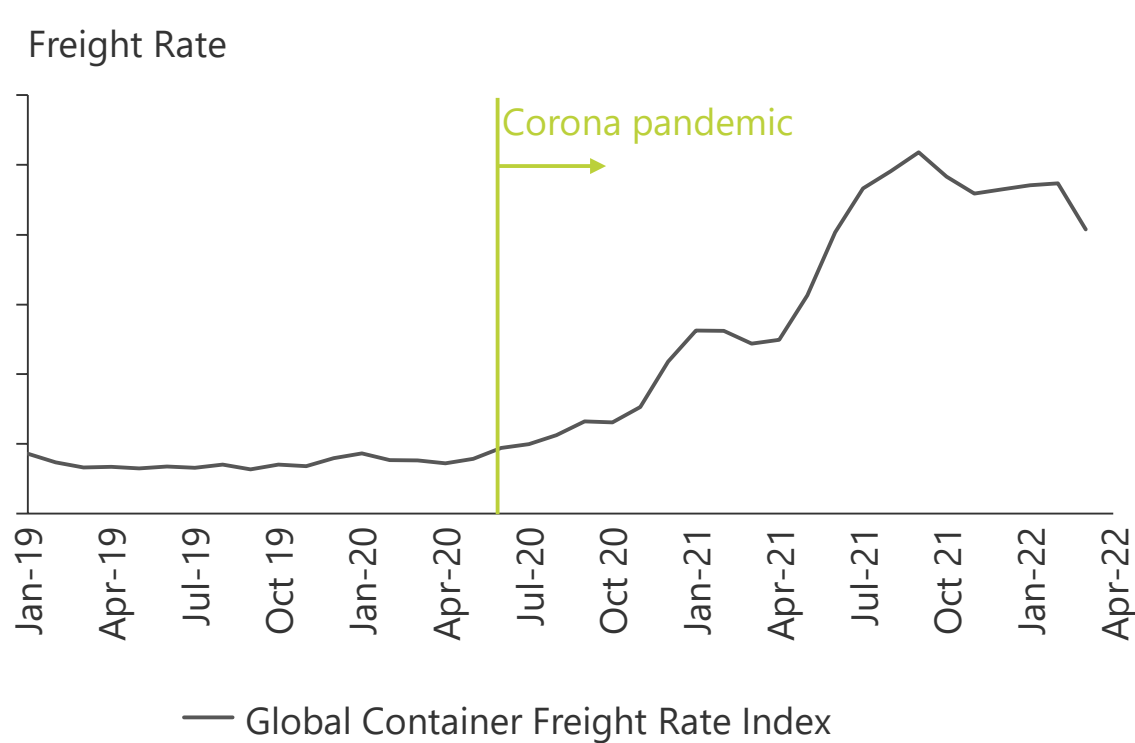

Shipping reliability & average delays

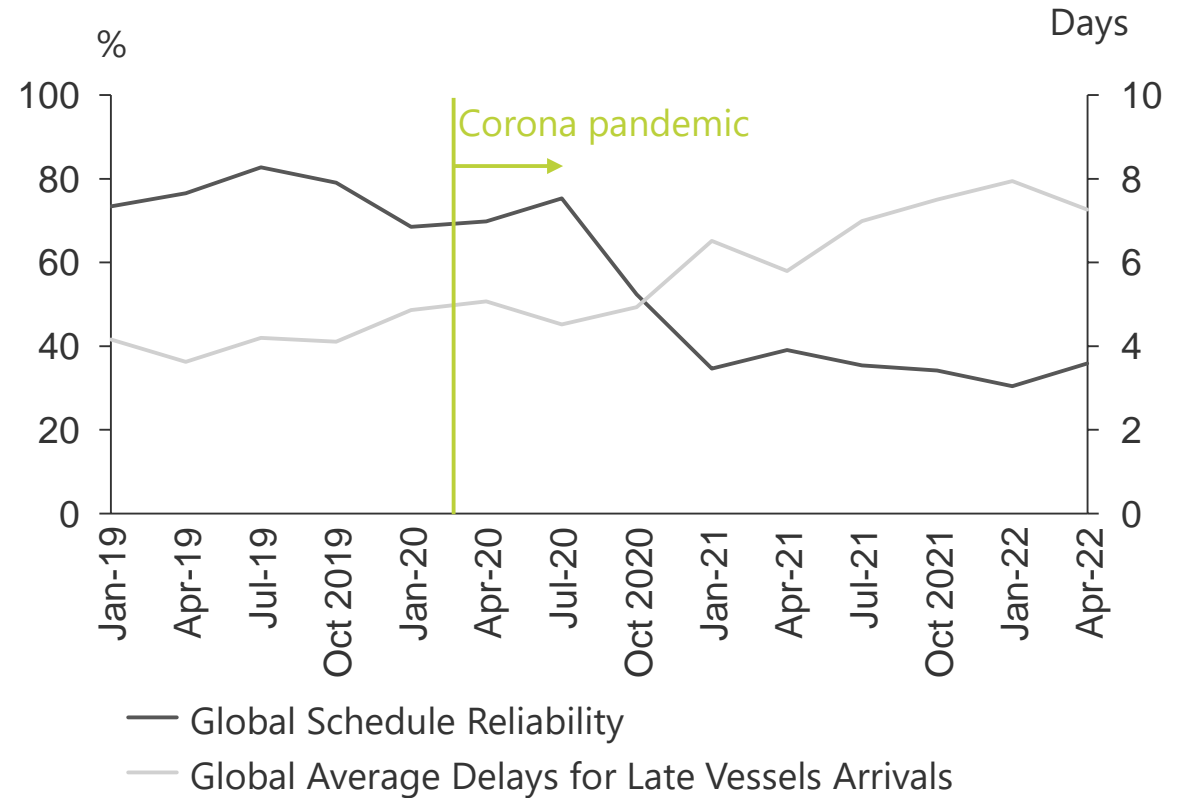

Source: Statista, 40 feet containers via 8 major routes incl. spot rates and short-term contracts.

Source: Sea Intelligence

Situation on logistics and energy

Energy prices increase – long-term effects not yet assessable

Electric Wholesale Price per Country

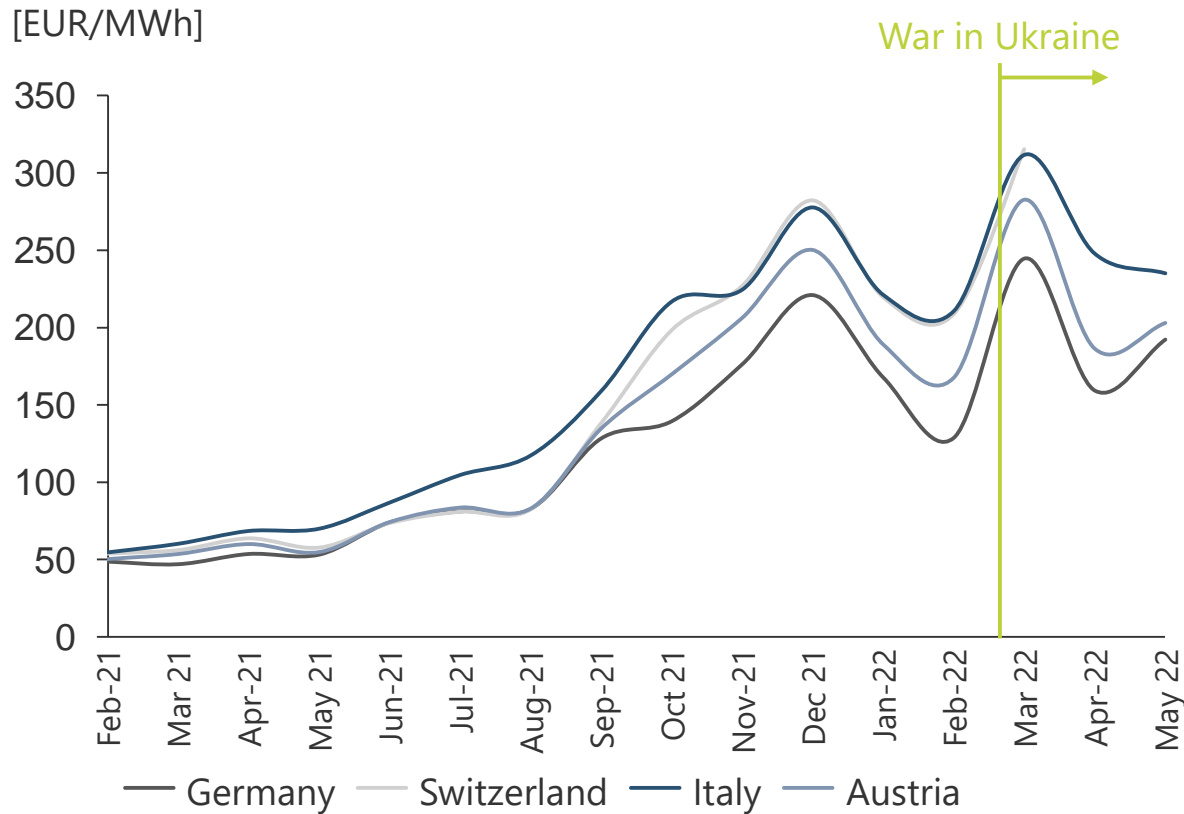

European Natural Gas Price

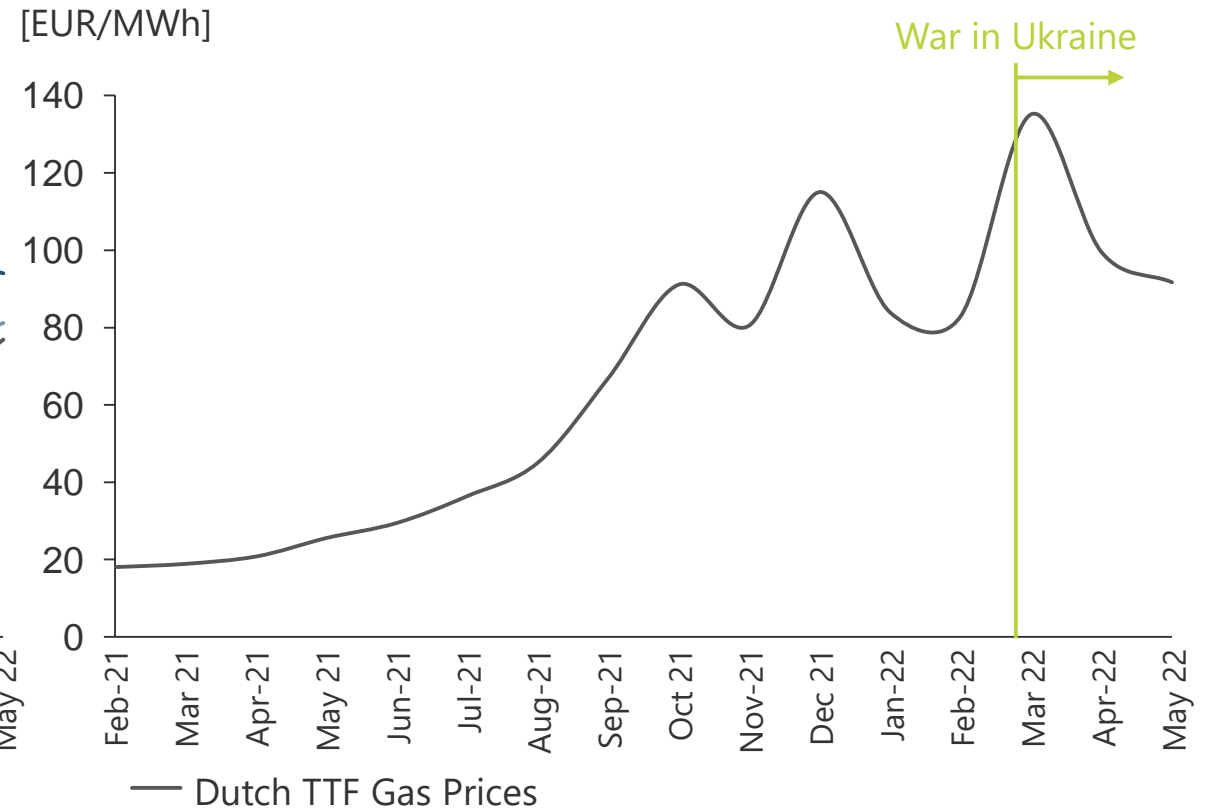

Source: Statista, Markets Insider, EnergyCharts.info / Fraunhofer ISE

Supply Chain Resilience

Increase the overall resilience level within TRUMPF manufacturing

Strategic program of CD Operations, BD MT & BD LT

- Supply Chain Resilience

...has a **crisis component** that reacts & controls the supply chain in escalation mode.

... additionally deals with the **structural component** in order to be able to react to changing markets in the long term, resilience further develops the supply chain.

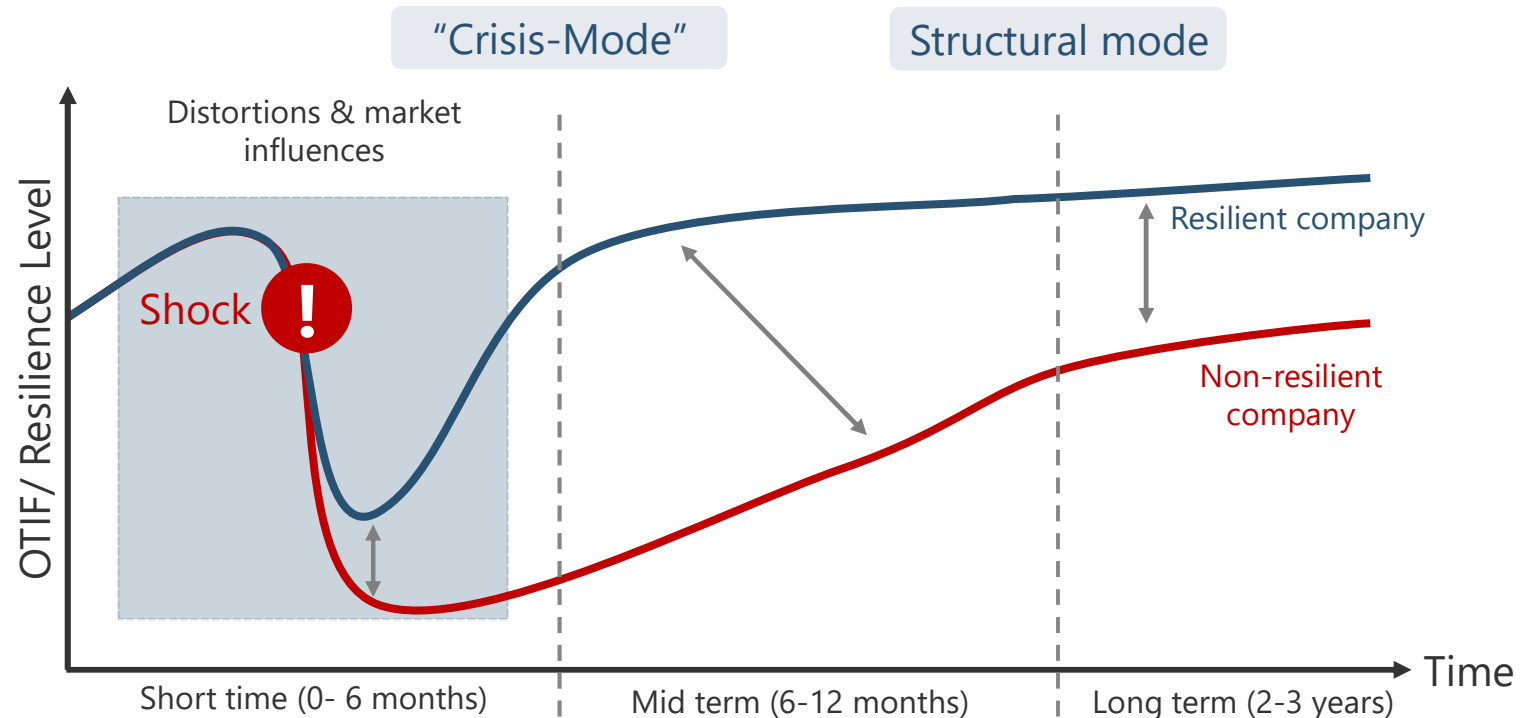

My personnel lessons learned over the last 2 years

¶ We cant **communicate too much** - share information in the organization. Make information transparent.

¶ Give **clear direction and orientation** - Crises are times of uncertainty. Not everyone is comfortable in such situations - to be honest - most of us are not ;) Leaders need to give direction and orientation. At TRUMPF our purpose, vision and mission gives as well good guidance.

¶ **Collaboration is key** - Collaboration across business units, functions, cross-border and across compaies helps to increase understanding - as well in emotional discussions and times of increasing pressure - and increases the quality of solutions. Different perspectives foster constructive discussion and the capability to cope with increasing complexity. One benefit we def can see - the "TRUMPF world" has become smaller, cross border collaboration better and mutual understanding has increased. With #couragetotransform we made collaboration already before the crisis one of the most important topics for TRUMPF.

¶ **Give kudos** - we sometimes forget to say thank you, well done. After solving one problem, we are off to solve the next ones. Taking time to say thank you and show appreciation can too easily be forgotten.

¶ **Dont forget long-term** - think crisis as a chance - Nevertheless ad-hoc collaboration is necessary we should not forget about long-term optimisations. Paradigms change at the moment. We need to start the transformations today for our future success. We work on such topics as production network, decoupling, multi-tier transparency, strategic buffering, redesign, complexity reductions - just to name a view. Always with the target to become more resilient.